

# InGaAs PIN-TIA Module

## Features

- High sensitivity
- Automatic gain control
- Wide dynamic range
- Differential output
- Operating temperature range -40°C to 85°C
- Single supply 3.3V/5V
- Hermetically sealed TO-46 package in pigtailed or receptacle housing with FC, ST, SC, LC, MU or SMA connector

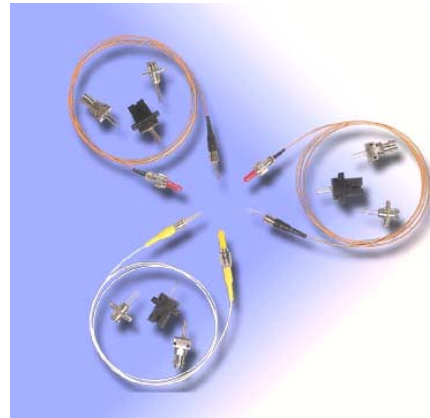

## Specifications (T=25°C +5V or +3.3V)

### Data Rate :155Mbps

Parameter	Symbol	Min.	Typ.	Max.	Unit
Gain (differential output)	G	200			mV/uW
Bandwidth	B	115	155	-	MHz
Spectral Range	$\lambda$	1150	-	1600	nm
Sensitivity	S				
-1		-37	-	-34	dBm
-2		-	-	-37	dBm
Input overload	P <sub>OL</sub>	-3	0	3	dBm
AGC loop time constant	-	-	1	-	dB/ms
Power supply current	I <sub>op</sub>	-	-	35	mA

### Data Rate : 622Mbps

Parameter	Symbol	Min.	Typ.	Max.	Unit
Gain (differential output)	G	50			mV/uW
Bandwidth	B	450	622	-	MHz
Spectral Range	$\lambda$	1150	-	1600	nm
Sensitivity	S				
-1		-	-	-25	dBm
-2		-	-	-28	dBm
Input overload	P <sub>OL</sub>	-3	0	3	dBm
AGC loop time constant	-	-	1	-	dB/ms
Power supply current	I <sub>op</sub>	-	-	35	mA

### Data Rate :1.25Gbps

Parameter	Symbol	Min.	Typ.	Max.	Unit
Gain (differential output)	G	0.4			mV/uW
Bandwidth	B	850	1250		MHz
Spectral Range	$\lambda$	1150	-	1600	nm
Sensitivity	S				
-1		-	-	-23	dBm
-2		-	-	-25	dBm
Input overload	P <sub>OL</sub>	-3	0	3	dBm
AGC loop time constant	-	-	1	-	dB/ms
Power supply current	I <sub>op</sub>	-	-	35	mA

# InGaAs PIN-TIA Module

## Data Rate : 2.5Gbps

Parameter	Symbol	Min.	Typ.	Max.	Unit
Gain (differential output)	G	0.4			mV/uW
Bandwidth	B	2	2.5	-	GHz
Spectral Range	$\lambda$	1150	-	1600	nm
Sensitivity	S				
-1		-	-	-22	dBm
Input overload	P <sub>OL</sub>	-3	0	3	dBm
AGC loop time constant	-	-	1	-	dB/ms
Power supply current	lop	-	-	35	mA

## Absolute Maximum Rating

	Symbol	Min.	Max.	Unit
Operating temperature	T <sub>o</sub>	-40	85	°C
Storage temperature	T <sub>stg</sub>	-55	125	°C
Operating voltage	V <sub>F</sub>	0	6.0	V
Optical input power	P <sub>OL</sub>	-	+3	dBm
Lead Soldering Temperature (10 sec)	T <sub>L</sub>	-	260	°C
Supply Voltage	5V	-	7	V
	3.3V	-	4	V

## Ordering Information

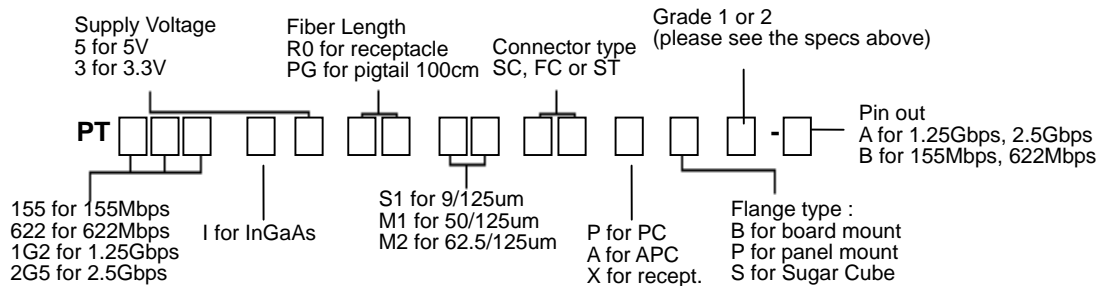

# InGaAs PIN-TIA Module

## Pin Connections

**BOTTOM VIEW**

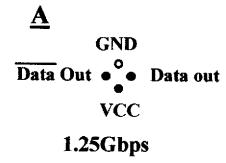
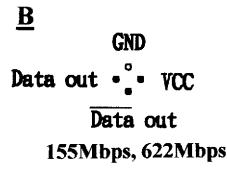

## Dimension

Pigtail Type

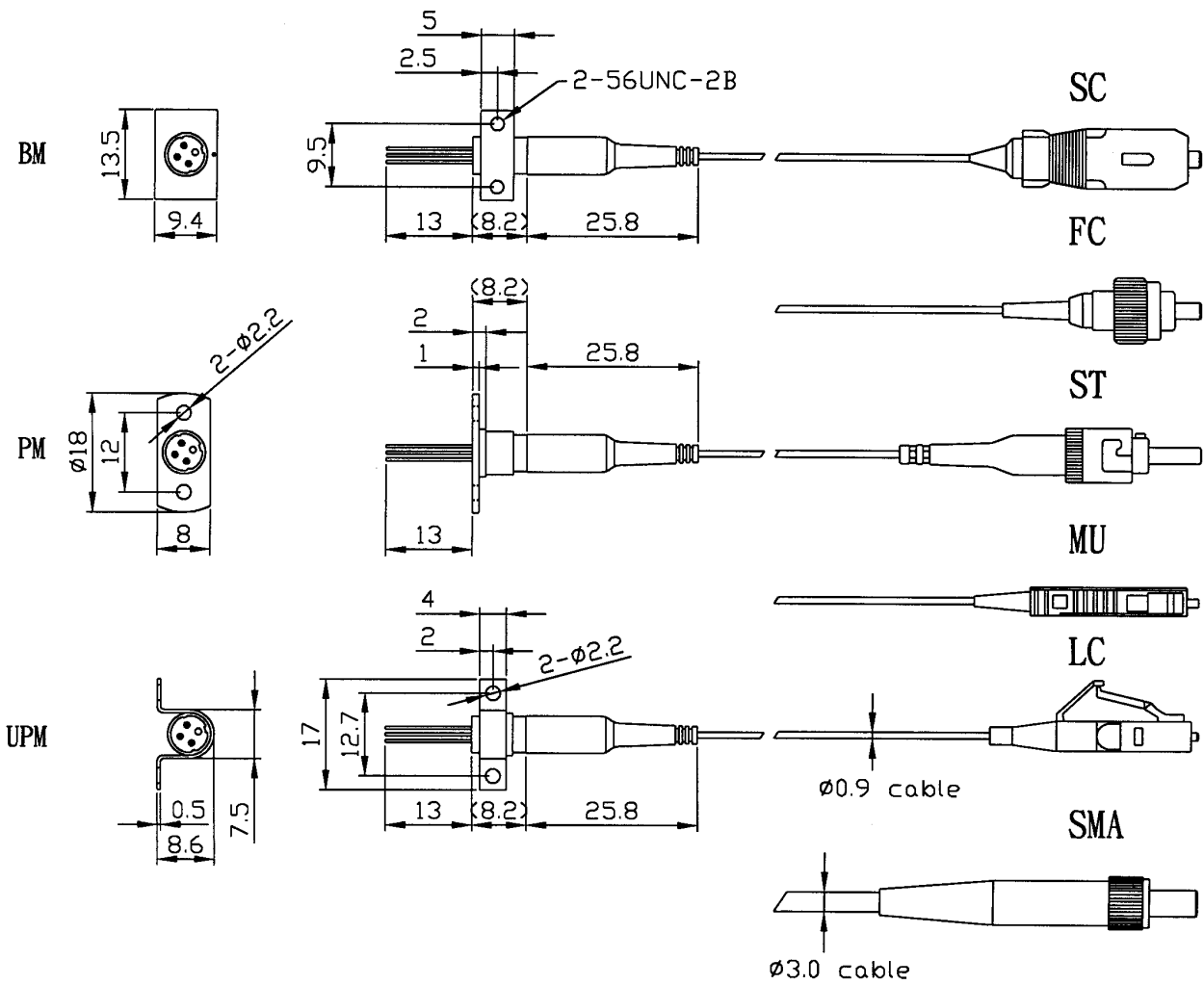

InGaAs PIN-TIA Module

# InGaAs PIN-TIA Module

Receptacle Type

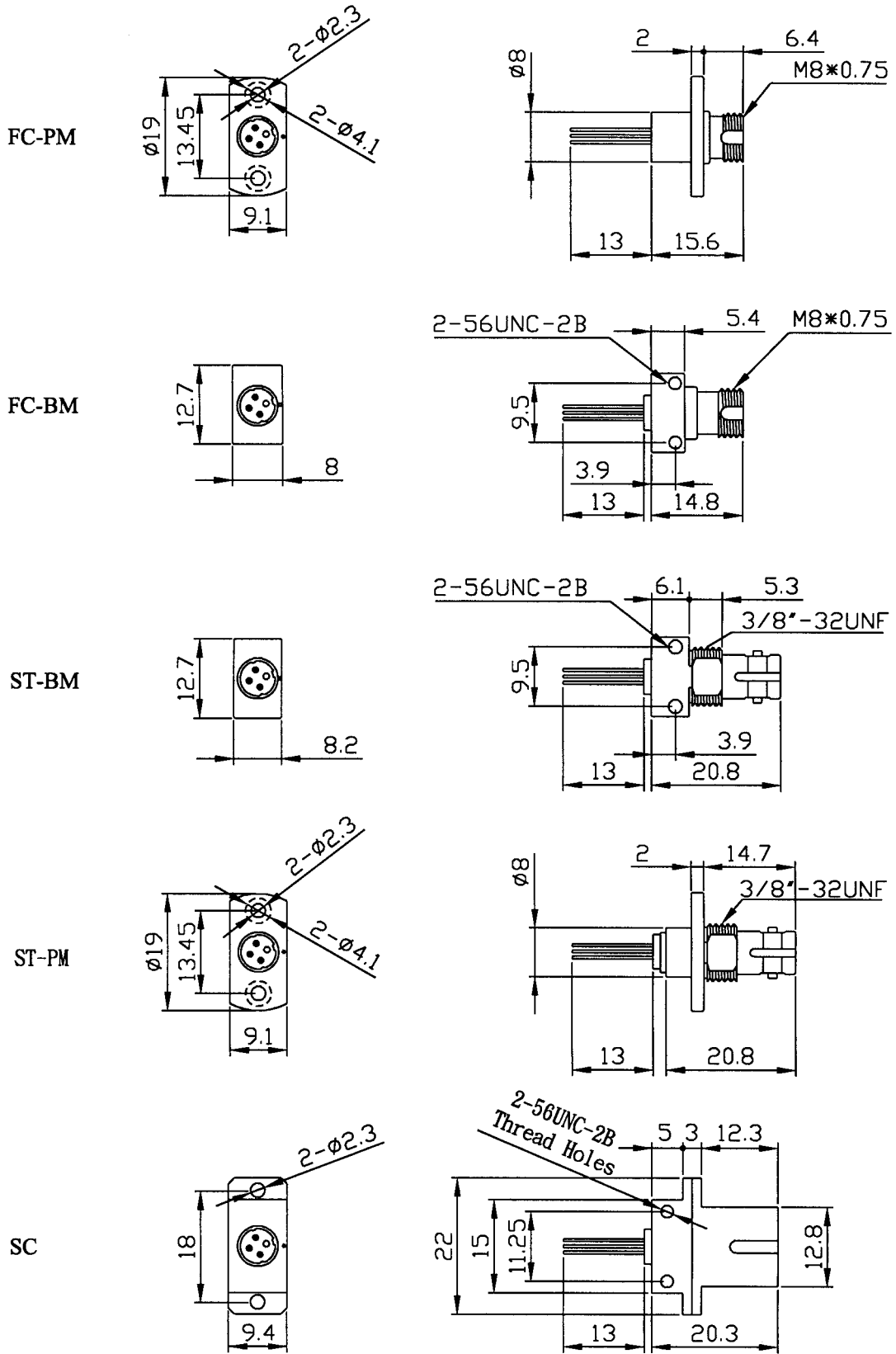

# InGaAs PIN-TIA Module

## Sugar Cube

### Pin Connections (Type B)

PIN No.	FUNCTION
1	NC
2	SIGNAL
3	Vee (GND)
4	NC
5	NC
6	Vcc
7	Vee (GND)
8	NC

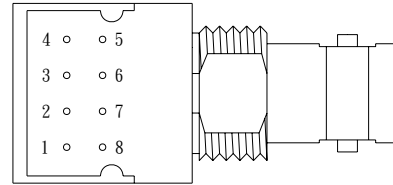

BOTTOM VIEW

### Dimension (ST Receptacle) Unit mm

